

The Magic of Moscow

The Editor reports on the Slava Cup.

The Metropol Hotel Moscow played host to the sixteenth edition of the Slava Cup, which is firmly established as one of the premier events in the bridge calendar. Once again Pavel Portnoy and his Committee had assembled an outstanding field from Russia and the rest of the world which included an outstanding collection of World, European and National Champions. They were in Moscow to pay homage to the memory of the talented Slava Grinyuk, who died an untimely death in his thirties. A new format saw 58 pairs compete over sixteen eight board rounds.

The concept of reporting a bridge event from the comfort of one's own home is catching on. It saves on expensive flights and hotel rooms so this year I sent Tacchi to Moscow to take the pictures whilst I remained in Sutton Benger. David Bird was also in Moscow as a guest of the organising committee.

Round 1 The Art of Bridge

On 11 February the Royal Academy in London opened a new exhibition – *Revolution: Russian Art 1917-1932*. It features works by such famous luminaries as Chagall, Kandinsky and Malevich, as well as works by less well known artists such as Petrov-Vodkin and Filonov. They all flourished during the years following the Revolution, but Chagall and Kandinsky both left Russia in the early twenties. Most of the exhibits have been loaned by Russian museums. No trip to Moscow is complete without a visit to the Pushkin Museum of Fine Arts which contains great works by Matisse, Van Gogh, Gauguin and Picasso (arts-museum.ru/?lang=en) and the Tretyakov Gallery a huge museum near Gorky Park containing Chagall's great murals for the State Jewish Theatre and Malevich's famous original *Black Square* from 1915 (tretyakovgallery.ru/en).

There is no doubt that bridge can be artistic. Would any of the deals from Round 1 of this year's Slava Cup produce masterpieces that might recalled in the years to come?

Board 1. Dealer North. None Vul.

	♠ 52	
	♥ K 10 3	
	♦ 10 8 3	
	♣ A Q 10 7 6	
♠ K Q 10 8 3		♠ 9 6 4
♥ 6 4		♥ Q 8 7 5
♦ A 6 5 2		♦ K Q J 9 7
♣ 3 2		♣ K
	♠ A J 7	
	♥ A J 9 2	
	♦ 4	
	♣ J 9 8 5 4	

West <i>Gusev</i>	North <i>Gromova</i>	East <i>Nikitina</i>	South <i>Ponomareva</i>
–	1NT*	Pass	Pass
2♦*	Pass	2♥*	Pass
2♠	Pass	3♠	All Pass
	1NT 10-12		
	2♦ Multilandy		
	2♥ Pass or correct		

♠ KQ1083	♠ 52	♠ 964
♥ 64	♥ K103	♥ Q875
♦ A652	♦ 1083	♦ KQJ97
♣ 32	♣ AQ1076	♣ K

♠ AJ7	♠ 52	♠ 964
♥ AJ92	♥ K103	♥ Q875
♦ 4	♦ 1083	♦ KQJ97
♣ J9854	♣ AQ1076	♣ K

If North finds a diamond lead the defenders are in a strong position. South can win the first spade with the ace and return a low club. As long as North gets the message and plays a second diamond South will score two ruffs and the contract will be two down.

In practice (have you noticed how often that can be different from theory?) North led the two of spades and although South won with the ace and returned the four of diamonds declarer could win, draw trumps and claim, +140 and 6 IMPs.

Board 2. Dealer East. N/S Vul.

	♠ J3	
	♥ KJ1097	
	♦ AK6	
	♣ QJ9	
♠ Q6		♠ K98742
♥ 8642		♥ Q
♦ 8		♦ J972
♣ K87653		♣ A4

	♠ A105	
	♥ A53	
	♦ Q10543	
	♣ 102	

West <i>Gusev</i>	North <i>Gromova</i>	East <i>Nikitina</i>	South <i>Ponomareva</i>
–	–	2♦*	Pass
3♠*	Double	4♠	Double
All Pass			
2♦ Multi			
3♠ Pass or correct			

North led the king of diamonds and when South followed with the ten she switched to the king of hearts. South overtook it with the ace and returned the ten of clubs, declarer winning with the king, ruffing a heart, ruffing a diamond, ruffing a heart and ruffing another diamond. The next heart was ruffed and overruffed and South cashed the ace of spades and the queen of diamonds for two down, -300.

With N/S able to take eleven tricks in either red suit and notrumps that looked quite promising for E/W and it proved to be worth 7 IMPs.

Board 3. Dealer South. E/W Vul.

♠ A54		♠ J1092
♥ J76		♥ 8542
♦ AK52		♦ 764
♣ A92		♣ K5

♠ 876		
♥ AKQ9		
♦ J10		
♣ Q1063		

West	North	East	South
<i>Gusev</i>	<i>Gromova</i>	<i>Nikitina</i>	<i>Ponomareva</i>
–	–	–	1NT*
Double	Redouble*	Pass	2♣
Pass	Pass	2♦	Pass
3♦	Pass	3♥	Pass
3NT	All Pass		

1NT 10-12
Rdbl Two suits

Was East hoping that 2♦ might be interpreted as showing both majors?

With her side having a clear majority of the high card points North should have doubled 3NT.

She led the four of clubs and when declarer ducked South's queen the ♥AKQ9 took the next four tricks. South switched to the seven of spades and North won with the queen and exited with a club to dummy's king. Declarer cashed two diamonds and the ace of clubs and exited with a diamond to force North to lead into the split spade tenace, still three down, -300 – and a missed opportunity for N/S, although they did open their account with a 4 IMP pickup.

Board 4. Dealer West. All Vul.

♠ Q85		♠ 2
♥ J1087		♥ K543
♦ AJ63		♦ K10754
♣ 108		♣ 732

♠ KJ964		
♥ Q2		
♦ 92		
♣ AQ95		

♠ A1073		
♥ A96		
♦ Q8		
♣ KJ64		

West	North	East	South
Gusev	Gromova	Nikitina	Ponomareva
Pass	1♠	Pass	2♣
Pass	2♠	Pass	4♠
All Pass			

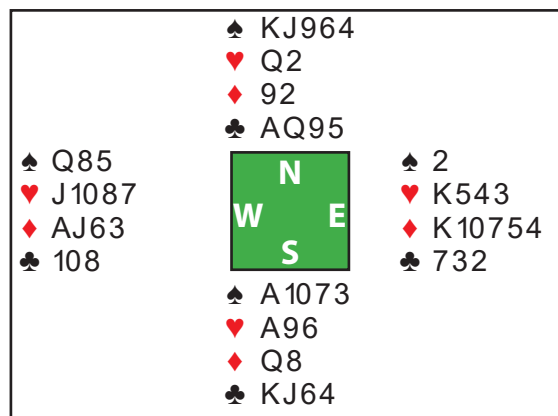

The spotlight was on East.

A trump lead solves declarer's problem in the trump suit and a heart lead (you lead away from a king?) is another way to hand declarer the contract on a plate. Leading either minor keeps the defenders in the game.

East went with the two of spades and that meant -620 and a loss of 9 IMPs.

E/W had the better of the remaining deals, going on to win by 11 IMPs, 41-19.

You can replay these deals at: <http://tinyurl.com/zoerjwh>

Round 2 The Romanovs

No visit to Moscow is complete without a visit to the Kremlin, the residence of the Tsars.

The Romanovs is the intimate story of twenty tsars and tsarinas, some touched by genius, some by madness, but all inspired by holy autocracy and imperial ambition. Simon Sebag Montefiore's gripping chronicle reveals their secret world of unlimited power and ruthless empire-building, overshadowed by palace conspiracy, family rivalries, sexual decadence and wild extravagance, and peopled by a cast of adventurers, courtesans, revolutionaries and poets, from Ivan the Terrible to Tolstoy, from Queen Victoria to Lenin.

To rule Russia was both imperial-sacred mission and poisoned chalice: six tsars were murdered and all the Romanovs lived under constant threat to their lives. Peter the Great tortured his own son to death while making Russia an empire, and dominated his court with a dining club notable for compulsory drunkenness, naked dwarfs and fancy dress. Catherine the Great overthrew her own husband – who was murdered soon afterwards – loved her young male favourites, conquered Ukraine and fascinated Europe. Paul was strangled by courtiers backed by his own son, Alexander I, who faced Napoleon's invasion and the burning of Moscow, then went on to take Paris. Alexander II liberated the serfs, survived five assassination attempts, and wrote perhaps the most explicit love letters ever written by a ruler. The Romanovs climaxes with a fresh, unforgettable portrayal of Nicholas and Alexandra, the rise and murder of Rasputin, war and revolution – and the harrowing massacre of the entire family.

Written with dazzling literary flair, drawing on new archival research, *The Romanovs* is at once an enthralling story of triumph and tragedy, love and death, a universal study of power, and an essential portrait of the empire that still defines Russia today.

In the second round we concentrate on the match between the third and fourth placed pairs – unluckily it was not as exciting as the Romanov dynasty.

Board 9. Dealer North. E/W Vul.

♠ 652 ♥ 86 ♦ 1092 ♣ J9872		♠ J9 ♥ 1073 ♦ Q653 ♣ A1063	♠ Q107 ♥ QJ5 ♦ KJ74 ♣ KQ5
		♠ AK843 ♥ AK942 ♦ A8 ♣ 4	
West	North	East	South
<i>Sliva</i>	<i>Serbin</i>	<i>Vorobey</i>	<i>Azaryeva</i>
–	Pass	1♦	2♦*
Pass	2♥	Pass	3♥
All Pass			
2♦	Majors		

Given that North might have held nothing at all for the initial response of 2♥, it is surprising that he did not go on to game when his partner showed a good hand.

Declarer won the club lead, cashed dummy's top spades and hearts, ruffed a spade and claimed eleven tricks,+200.

Missing the game cost N/S 6 IMPs.

Board 11. Dealer South. None Vul.

♠ KJ102 ♥ K97 ♦ K6 ♣ 10976		♠ 75 ♥ 108 ♦ A1053 ♣ AKQ54	♠ A964 ♥ QJ5 ♦ QJ987 ♣ J
		♠ Q83 ♥ A6432 ♦ 42 ♣ 832	
West	North	East	South
<i>Sliva</i>	<i>Serbin</i>	<i>Vorobey</i>	<i>Azaryeva</i>
–	–	–	Pass
Pass	1♦	Pass	1♥
Double	2♣	2♠	Pass
Pass	3♣	Double	All Pass

No doubt there were systemic reasons that prevented North from opening 1♣ (I suspect it was the Polish variety). When he somewhat dubiously took a third bid (didn't West's double suggest he had length in clubs?) East doubled to show he had a good hand and West was happy to play for penalties.

East led the jack of clubs and declarer won with the king and ducked a diamond to West's king. Back came the ten of clubs, East throwing the four of spades as declarer won with the ace. he cashed the ace of diamonds and ruffed a diamond, but West overruffed and switched to the king of hearts. In due course the defenders added two hearts, two spades and a diamond to their total, two down, -300 and a loss of 5 IMPs.

Board 13. Dealer North. All Vul.

♠ KQ73			
♥ 106			
♦ K98432			
♣ 5			
♠ 9542			♠ 108
♥ AK5			♥ J743
♦ 65			♦ J7
♣ Q863			♣ AJ1097
♠ AJ6			
♥ Q982			
♦ AQ10			
♣ K42			
West	North	East	South
<i>Sliva</i>	<i>Serbin</i>	<i>Vorobey</i>	<i>Azaryeva</i>
–	Pass	Pass	1NT
Pass	2♣*	Double	2♥
3♣	3♦	Pass	3NT
All Pass			

With North showing an invitational hand with spades and longer diamonds South went for the game bonus and right he was. West led the three of clubs and East won with the ace and returned the jack so that was eleven tricks,+660. That looked like a good result, but to their credit most of the N/S pairs reached 3NT and there was no swing.

EW generally had the better of things and they moved into second place.

You can replay these deals at: <http://tinyurl.com/j2prw3b>

Round 3 At Arm's Length

As I mentioned earlier I am experimenting by working on the Bulletin from my office in the sleepy Wiltshire village of Sutton Benger. Having lived in London (and then Bath) for many years I appear to be following the path of Hercule Poirot, who retires to a village near the home of a friend to enable him to pursue his retirement project of perfecting vegetable marrows, although I am currently more interested in the perfecting the contents of my wine cellar than those of my garden. Poirot is forced out of retirement by the murder of his friend Roger Ackroyd, so I trust everyone will take good care of Ron Tacchi!

In Round 3 I followed the fortunes of the third and fourth placed pairs.

Board 17. Dealer North. None Vul.

♠ K543 ♥ 2 ♦ AK75 ♣ 8754		♠ A ♥ KQ54 ♦ J863 ♣ AK93	♠ QJ8762 ♥ A8 ♦ 94 ♣ Q62
♠ 109 ♥ J109763 ♦ Q102 ♣ J10			

West	North	East	South
<i>Tatarkin</i>	<i>Baldursson</i>	<i>Bakal</i>	<i>Haraldsson</i>
–	2♠	Double	Pass
3♦	Pass	3♠*	Pass
3NT	Pass	4♦	Pass
5♦	Pass	6♦	All Pass

4-4-4-1 shapes are notoriously difficult to evaluate, but perhaps East should have let matters rest when West could do no more than raise to 5♦.

North led the queen of spades and declarer won perforce with dummy's ace, played a diamond to the ace and a heart. North took the ace and South trump queen was the setting trick, +50.

Would you be confident of making 3NT on a spade lead? After winning with the ace you can play a diamond to the ace and a heart to the king, but I think you are going to have to play North for the ♥A8 alone.

The swing reflected the fact that you might fail in the nine trick game, N/S picking up 6 IMPs.

Board 18. Dealer East. N/S Vul.

♠ QJ103 ♥ 4 ♦ AQ1065 ♣ Q53		♠ A84 ♥ AK63 ♦ J9 ♣ 10986	♠ K7 ♥ Q109875 ♦ 7432 ♣ 2
♠ 9652 ♥ J2 ♦ K8 ♣ AKJ74			

West	North	East	South
<i>Tatarkin</i>	<i>Baldursson</i>	<i>Bakal</i>	<i>Haraldsson</i>
–	–	1♣	Pass
1♠	Pass	1NT	Pass
2♦*	Pass	2♠	All Pass

2♦ Checkback

North led the two of clubs and South played three rounds of the suit, North ruffing and exiting with a heart. Declarer won with dummy's ace, played the jack of diamonds for the king and ace and the three of spades for the king and ace. he cashed the nine of diamonds and claimed the rest, +170. With many pairs making 3NT it cost E/W 4 IMPs.

Board 21 featured the rare Biltcliffe Coup, and is one of the featured deals in David Bird's report below.

Board 24. Dealer West. None Vul.

	♠ 1032 ♥ J2 ♦ 1085 ♣ 109732		
♠ Q8 ♥ 93 ♦ QJ63 ♣ AKJ64		♠ AJ95 ♥ Q10854 ♦ A97 ♣ Q	
	♠ K764 ♥ AK76 ♦ K42 ♣ 85		
West	North	East	South
<i>Tatarikin</i>	<i>Baldursson</i>	<i>Bakal</i>	<i>Haraldsson</i>
1♦	Pass	1♥	Pass
2♣	Pass	3NT	All Pass

South cashed the ace of hearts and switched to the six of spades, declarer taking North's ten with the jack, unblocking the queen of clubs and playing a diamond to the jack. He cashed three rounds of clubs, pitching two hearts and a spade as south discarded the six and seven of hearts. The queen of spades ran to South's king and he exited with a spade to declarer's ace which left a four card ending:

	♠ — ♥ J ♦ 108 ♣ 10		
♠ — ♥ 9 ♦ Q63 ♣ —		♠ — ♥ Q10 ♦ A9 ♣ —	
	♠ 4 ♥ K ♦ K2 ♣ —		

If declarer exits with a heart South wins and can cash a spade, but must then lead into the split diamond tenace. However, unable to read the position he cashed the ace of diamonds and was one down when the king failed to appear, -50 and a loss of 9 IMPs.

Clearly declarer can do better. One line is to return a spade at trick three. If South ducks dummy's queen wins and declarer can come to hand with the queen of clubs and play a diamond, assuring nine tricks.

The Icelanders won by 40 IMPs and swept to the top of the table.
 You can replay these deals at: <http://tinyurl.com/jxkm49d>

Birthday Present (by David Bird)

In a piece in the first bulletin, I described the notion of a nett swing. That's when you have a chance to gain IMPs but fail to do so and lose IMPs instead. Nett swings can be around 30 IMPs on big deals.

I did not have long to wait for the first sizeable nett swing in the Slava Cup. This was board 6 at Table 1:

Board 6. Dealer East. E/W Vul.

	♠ 8										
	♥ 9874										
	♦ K3										
	♣ AJ6543										
♠ K107652	<table border="1" style="width: 40px; height: 40px; margin: auto;"> <tr><td></td><td style="text-align: center;">N</td><td></td></tr> <tr><td style="text-align: center;">W</td><td></td><td style="text-align: center;">E</td></tr> <tr><td></td><td style="text-align: center;">S</td><td></td></tr> </table>		N		W		E		S		♠ Q93
	N										
W		E									
	S										
♥ KQ63		♥ 105									
♦ 5		♦ AQ1064									
♣ 87		♣ KQ10									
	♠ AJ4										
	♥ AJ2										
	♦ J9872										
	♣ 92										
West	North	East	South								
<i>Rappoport</i>	<i>Gromov</i>	<i>Chubarova</i>	<i>Dubinina</i>								
–	–	1♣	1♦								
1♠	2♣	Double	Pass								
2♥	2NT	Pass	Pass								
4♠	All Pass										

North's 2♣ was natural and East's Support Double showed 3-card spade support. West might have signed off in 2♠ but made the stronger move of 2♥. Gromov now bid the Unusual NT, inviting partner to advance in one of the minors. I was expecting South to bid 3♣, but I did mention in voice commentary on *Bridge Base* that some players would pass 2NT. To my surprise Dubinin took this option. My next prediction was that West would bid 3♠. Wrong again, he bid a bold 4♠.

The cards lie well for this contract and it seemed that South's pass of the Unusual NT had given away the position of the ♠J. +620 figured to be a useful swing for East-West. Declarer won the ♦K lead with the ace and led the ♥10, South winning with the ace. After a club to the ace and a club back, I rather thought that West would play South for ♠A-J-x, after his refusal to bid a minor on the second round. No, a spade was played to the king and the game went one down for a loss of 10 IMPs against the datum of -280. Making the game would have been a gain of 8 IMPs, so it was a nett swing of 18. Perhaps the opponents knew that it was Gromov's birthday and thought that a present was in order.

Right, how many of you know what a Biltcliffe Coup is? It is not very common because to achieve it you have to perform the following five conditions:

- The opponents stop in a part-score
- You protect with a bid in the pass-out set
- The opponents then bid game
- You double them
- They make it

Many years ago, I coined the term after a player called Biltcliffe (a member of Eric Crowhurst's team) who achieved the coup three times in a single match.

You can imagine how excited I was when on board 21, there was potential for a Biltcliffe Coup:

Board 21. Dealer North. N/S Vul.

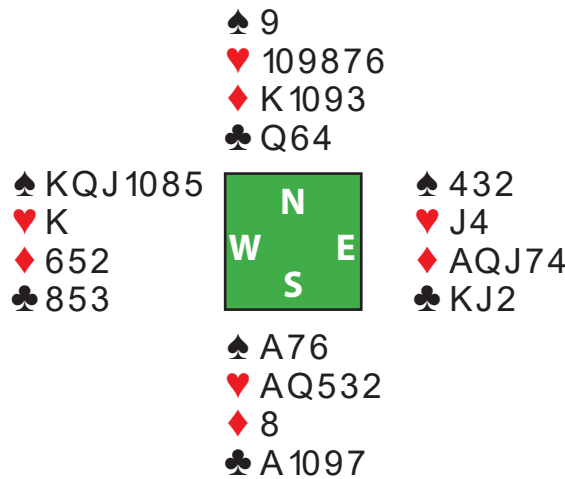

West	North	East	South
<i>Tatarkin</i>	<i>Baldursson</i>	<i>Bakal</i>	<i>Haraldsson</i>
–	Pass	1♣	1♥
1♠	3♥	Pass	Pass
3♠	Pass	Pass	4♥
Double	All Pass		

A pre-emptive raise to 3♥, when vulnerable against not, shows a fair amount of playing strength and I expected South to raise to 4♥. No, it was another case of commentator's curse and he passed. One by one the first four conditions of the Biltcliffe Coup were fulfilled. My heart rate went up considerably, you will understand. Now, would they make it? Say they lost a heart and a diamond. Declarer would then surely only lose one club – leading towards the queen and then finessing the 10. Yes!

Declarer won the ♠K lead and led a diamond to the king and ace. When a trump was returned, he thought for a while and then played the queen, losing to the king. Back came the ♣8 to the jack and ace and the contract was home. Hurray! My heart rate has nearly returned to normal.

You can replay these deals at: <http://tinyurl.com/zwc3ouw>

Round 4 Red Square

Red Square is a crime novel by Martin Cruz Smith, primarily set in Moscow, Munich and Berlin between August 6 and August 21, 1991. It features the Investigator Arkady Renko, and takes place during the period of the collapse of the Soviet Union.

Without giving anything away the plot has a great deal to do with the avant garde piece by Malovich called "Red Square" painted in 1915.

The iconic site is one which you simply must visit during any stay in Moscow.

In Round 4 we visit the table occupied by the leaders and their closest rivals:

Board 25. Dealer North. E/W Vul.

	♠ 74 ♥ J1075 ♦ AK4 ♣ AJ73			
♠ K9 ♥ K963 ♦ Q92 ♣ Q852		♠ Q105 ♥ A ♦ J108753 ♣ 1096		
	♠ AJ8632 ♥ Q842 ♦ 6 ♣ K4			
	West <i>Dubin</i> – Pass	North <i>Baldursson</i> 1♦ 4♥	East <i>Gromov</i> Pass All Pass	South <i>Haraldsson</i> 2♠*
2♠	Invitational with 5+♠ and 4♥			

East led the jack of diamonds and declarer won in hand and played the five of hearts to East's ace. He won the diamond return pitching a spade from dummy and played the ten of hearts, East throwing a diamond. If West wins that and returns a heart declarer will have too much to do, but when he ducked declarer took full advantage. He ruffed a diamond with the queen of hearts, cashed the king of clubs, played a club to the jack, cashed the ace, ruffed a club and cashed the ace of spades. He was sure to score a trick with the jack of hearts, +420, giving the leaders 6 IMPs.

If declarer plays East for a singleton ace of hearts and leaves trumps alone, then the line he followed would leave the defenders helpless.

Board 28. Dealer West. N/S Vul.

	♠ A64		
	♥ 864		
	♦ Q72		
	♣ 8542		
♠ 53	<div style="border: 1px solid black; padding: 5px; width: 60px; margin: 0 auto;"> N W E S </div>		♠ 872
♥ KQ10975			♥ J32
♦ K65			♦ AJ43
♣ Q6			♣ A93
	♠ KQJ109		
	♥ A		
	♦ 1098		
	♣ KJ107		

West	North	East	South
<i>Dubin</i>	<i>Baldursson</i>	<i>Gromov</i>	<i>Haraldsson</i>
1♥	Pass	2♥	2♠
3♥	3♠	4♥	4♠
Pass	Pass	Double	All Pass

With such a flat hand should North raise in spades?

West led the king of hearts and declarer won and ran the nine of diamonds. East won with the jack and returned a diamond, so the defenders took two more tricks in the suit before East exited with a heart. Declarer ruffed, cashed the king of spades and then tried the king of clubs, two down, -500 and a loss of 8 IMPs.

4♥ was allowed to make a couple of times – if North starts with the ace of spades then a club switch is required at trick two.

Board 30. Dealer East. None Vul.

	♠ 1042		
	♥ A962		
	♦ KJ107		
	♣ 75		
♠ KJ763	<div style="border: 1px solid black; padding: 5px; width: 60px; margin: 0 auto;"> N W E S </div>		♠ 985
♥ KJ75			♥ Q10
♦ 842			♦ 653
♣ J			♣ 109864
	♠ AQ		
	♥ 843		
	♦ AQ9		
	♣ AKQ32		

West	North	East	South
<i>Dubin</i>	<i>Baldursson</i>	<i>Gromov</i>	<i>Haraldsson</i>
–	–	Pass	1♣*
2♥*	Double*	Pass	2♠*
Pass	2NT	Pass	3NT
All Pass			

- 1♣ Strong Club
- 2♥ Hearts and spades
- 2♠ Spade stopper

Although this will not be the most exciting deal we will see it did contain a theoretical point in the bidding. With West showing both majors South could bid the one he had a stopper in. East led the nine of spades and declarer took his nine tricks, +400 – a 1 IMP loss.

In a low scoring match the Russian pair had marginally the better of the exchanges and they moved to the top of the table.

You can replay these deals at: <http://tinyurl.com/grydf5a>

Round 5 Three Stations

Three Stations another novel by Martin Cruz Smith takes its title from the informal name for Moscow’s Komsomol Square, where the Yaroslavl, Leningrad and Kazan train stations converge. As usual it features the Investigator Arkady Renko.

The author has infused his main character with a pristine Slavic humor. Here is an extract from the book:

“This wasn’t Arkady’s Moscow anymore,” we’re told as he reaches the affluent strip between the Kremlin and the Church of the Redeemer. When he parks to make a call, a woman in a white S.U.V. pulls up. “This is a ‘No Lada Zone,’ ” she tells him.

“We are in Russia?” Arkady asks.

“Yes.”

“In Moscow?”

“Yes, of course.”

“And the Lada is a Russian car?”

“One Lada can reduce the value of an entire city block.”

“I had no idea.”

“I mean, were you towed here?”

“Passing through.”

“I knew it. ‘Through traffic’ is the worst. Why did you stop?”

“We’re releasing rats.”

“That’s it. I’m alerting Security.”

I was hoping to report three deals from Round 5, but another caught my attention. Well, there are four railway stations on a Monopoly board, so I’ll use that as my excuse.

Board 1. Dealer North. None Vul.

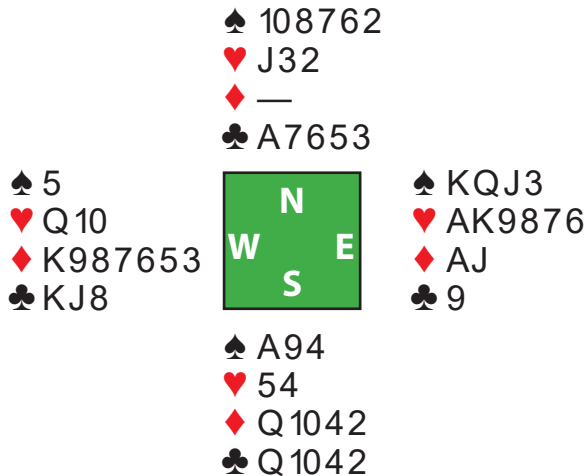

West	North	East	South
<i>Shudnev</i>	<i>Gromov</i>	<i>Perekhrest</i>	<i>Dubinin</i>
—	Pass	1♣*	Pass
1♦*	1♠	Double	2♠
3♠	Pass	5♥	Pass
6♥	Double	All Pass	

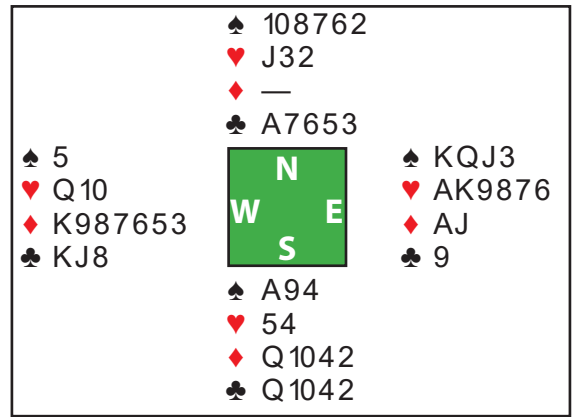

It looks as if East's 1♣ was strong (maybe another playing Polish Club?) but I wonder why East doubled 1♠ instead of bidding 2♥? It looks as if West's 3♠ was an attempt to reach 3NT but when East jumped to 5♥ it was clear that message had not been received. West's raise to 6♥ mean that train had not only failed to reach the station -it had been derailed well short of it.

South led the ace of spades and when North followed with the ten the four of diamonds hit the table, North ruffing and cashing the ace of clubs for +300 and 11 IMPs. I suppose it could have been worse.

Board 2. Dealer East. N/S Vul.

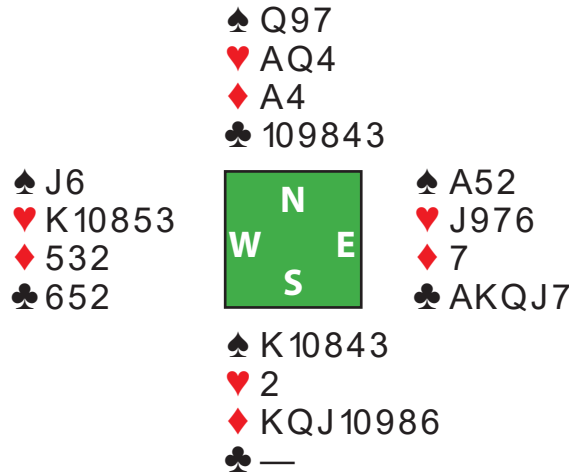

West	North	East	South
<i>Shudnev</i>	<i>Gromov</i>	<i>Perekhrest</i>	<i>Dubinin</i>
—	—	2♣*	2♦
2♥	3NT	4♦*	4♠
Pass	5♦	Double	All Pass
2♣	Limited with clubs		
4♦	Splinter		

West led the five of clubs and declarer ruffed, drew trumps and after cashing a fourth diamond played a spade to the queen and ace. He ruffed the club return, played a heart to the ace and ran the nine of spades—no overtrick, +750, just 3 IMPs.

Board 4. Dealer West. All Vul.

♠ AQ1092 ♥ 6 ♦ A853 ♣ 642		♠ KJ854 ♥ AQ753 ♦ 92 ♣ 7
♠ 763 ♥ J104 ♦ KQ74 ♣ K105		♠ — ♥ K982 ♦ J106 ♣ AQJ983

West	North	East	South
<i>Shudnev</i>	<i>Gromov</i>	<i>Perekhrest</i>	<i>Dubin</i>
Pass	1♠	Pass	1NT*
Pass	2♦	Pass	3♣
Pass	4♣	Pass	5♣
Pass	Pass	Double	All Pass

1NT Forcing for one round

Against this slightly hesitant auction East found a 'Tiger Double' in the style of Jeremy Flint. West led the king of diamonds and declarer won with dummy's ace and played back a diamond, West winning and playing a third round, East ruffing and cashing the ace of hearts before exiting with a heart. Declarer could win, ruff a heart, pitch a heart on the ace of spades and play trumps, West's king representing the second undertrick, -500.

Declarer can escape for one down by pitching a diamond on the ace of spades at trick two and then playing a heart.

Board 7. Dealer South. All Vul.

♠ AJ932 ♥ — ♦ J10963 ♣ K85		♠ 10854 ♥ KQ ♦ AQ7 ♣ J972
		♠ Q6 ♥ AJ108432 ♦ 854 ♣ 3
		♠ K7 ♥ 9765 ♦ K2 ♣ AQ1064

West	North	East	South
<i>Shudnev</i>	<i>Gromov</i>	<i>Perekhrest</i>	<i>Dubin</i>
—	—	—	1NT*
2♠*	4♥	4♠	Pass
Pass	Double	All Pass	

1NT 12+-15 may be 4414
 2♠ Spades and a minor

South resisted and temptation to support hearts and right he was.

North led his club and South won with the ace and returned the four, North ruffing and switching to the five of diamonds. Declarer went up with dummy's ace, played a spade to the ace and claimed nine tricks, one down, -200, just a single IMP for N/S who were displaced as leaders by Turkey's Baskan & Sohtorik.

You can replay these deals at: <http://tinyurl.com/zhhuuof>

Round 6 The Night Watch

Night Watch is a fantasy novel by the Russian author Sergei Lukyanenko to feature his fictional world of the Others. Lukyanenko wrote the story in and it revolves around a confrontation between two opposing supernatural groups (known as "Others"): the Night Watch, an organization dedicated to policing the actions of the Dark Others – and the Day Watch, which polices the actions of the Light Others.

When Ron Tacchi told me that Friday's Bulletin was already full I was able to complete my report on Round 6 in the evening.

Board 9. Dealer North. E/W Vul.

♠ J52		
♥ KQ5		
♦ 108		
♣ J9876		
♠ AQ10	<div style="border: 1px solid black; background-color: #4CAF50; color: white; padding: 10px; width: 60px; margin: 0 auto;"> N W E S </div>	♠ 984
♥ J1096		♥ A87
♦ AQJ9		♦ K743
♣ A10		♣ KQ5
	♠ K763	
	♥ 432	
	♦ 652	
	♣ 432	

	West	North	East	South
	<i>Dubin</i>	<i>Baskan</i>	<i>Gromov</i>	<i>Sohtorik</i>
	–	Pass	Pass	Pass
	1♣*	Pass	1NT	Pass
	2♣	Pass	2♦*	Pass
	2NT	Pass	3NT	All Pass
1♣	Strong			
2♣	Stayman			
2♦	No major			

This deal passes Bob Hamman's test – 6♦ is a good slam because it makes (and so does 6NT). No less than nine pairs reached a slam, four in diamonds and three in notrumps. You picked up 11/12 IMPs depending on the strain – except for the unfortunate declarer who went down in 6♦, which cost 14 IMPs. Stopping in game cost N/S 5 IMPs.

Board 10. Dealer East. All Vul.

	♠ AJ ♥ KQ85 ♦ K10 ♣ A10765		
♠ 10832 ♥ AJ7632 ♦ J ♣ 32	<div style="border: 1px solid black; padding: 5px; width: 60px; margin: 0 auto;"> N W E S </div>	♠ KQ974 ♥ 4 ♦ 8743 ♣ K94	
	♠ 65 ♥ 109 ♦ AQ9652 ♣ QJ8		
West	North	East	South
— Pass	— 3NT	Pass All Pass	2♦

East led the king of spades and declarer won with the ace and followed the idea expounded by Harrison-Gray (and later Patrick Jourdain) of playing of his long suit. Five rounds of diamonds produced this ending:

	♠ J ♥ KQ8 ♦ — ♣ A106		
♠ 1032 ♥ AJ ♦ — ♣ 32	<div style="border: 1px solid black; padding: 5px; width: 60px; margin: 0 auto;"> N W E S </div>	♠ Q974 ♥ 4 ♦ — ♣ K9	
	♠ 6 ♥ 109 ♦ 6 ♣ QJ8		

On the last diamond declarer threw a heart from dummy as West parted with the two of clubs. What should East discard?

He went with the four of spades and when declarer ran the queen of clubs he won with the king, played a heart to partner's ace and collected three spade tricks for one down.

Declarer had missed a difficult chance.

Once East has thrown a spade declarer can play a heart. West can win with the ace and play a spade, but East can only take three tricks in the suit and will then have to play a club, giving dummy the last two tricks.

To avoid this East must keep his spade intact and pitch a heart on the last diamond.

This low scoring (and well played) affair went in favour of the Russian pair to the tune of 7 IMPs, leaving them in second place, just ahead of their opponents.

You can replay these deals at: <http://tinyurl.com/j9yvwm6>

Round 7 An Exciting Five Boards *by David Bird*

The first set on Saturday contained a sequence of five great deals. That was bad luck for Mark Horton (who was delaying his entry until the second set) and good luck for me!

Board 19. Dealer South. E/W Vul.

♠ —		♠ —	
♥ J1094		♥ AK107432	
♦ AK		♥ AQ7	
♣ Q1076432		♦ J3	
♠ QJ965	<div style="border: 1px solid black; padding: 5px; width: 40px; margin: 0 auto;"> N W E S </div>	♠ AK107432	
♥ K8		♥ AQ7	
♦ Q10875		♦ J3	
♣ 9		♣ K	
		♠ 8	
		♥ 6532	
		♦ 9642	
		♣ AJ85	
West	North	East	South
<i>Sohtorik</i>	<i>Vorobey</i>	<i>Baskan</i>	<i>Sliva</i>
—	—	—	Pass
Pass	2♣	4♠	5♣
5♠	6♣	Double	All Pass

Vorobey, who could not expect to score a club trick against 5♠, took out insurance in 6♣ and was doubled by East. He ruffed the spade lead, drew trumps and cashed his top diamonds. When he led the ♥J, Baskan won with the ♥Q. He might have reasoned that declarer would have led hearts from the dummy if held the ♥K-J. Playing the ♥7 next would still mean two down but East cashed the ♥A, dropping partner's ♥K, and that was only one down. +100 against a +110 datum for 0 IMPs.

Another interesting board followed immediately:

Board 20. Dealer West. All Vul.

♠ 10		♠ A654	
♥ KJ972		♥ Q8	
♦ 1098		♦ K653	
♣ A1072		♣ 863	
♠ KJ9832	<div style="border: 1px solid black; padding: 5px; width: 40px; margin: 0 auto;"> N W E S </div>	♠ A654	
♥ 53		♥ Q8	
♦ —		♦ K653	
♣ KQ954		♣ 863	
		♠ Q7	
		♥ A1064	
		♦ AQJ742	
		♣ J	

West	North	East	South
<i>Sohtorik</i>	<i>Vorobey</i>	<i>Baskan</i>	<i>Sliva</i>
3♠	Pass	4♠	Double
Pass	5♥	All Pass	

	♠ 10	
	♥ KJ972	
	♦ 1098	
	♣ A1072	
♠ KJ9832		♠ A654
♥ 53		♥ Q8
♦ —		♦ K653
♣ KQ954		♣ 863
	♠ Q7	
	♥ A1064	
	♦ AQJ742	
	♣ J	

At Table 2 East's raise to 4♠ was passed out and the defenders claimed their club ruffs for two down. Here Sliva entered with a double and Vorobey had to decide whether to defend or attempt 11 tricks in hearts. He chose to bid 5♥ and the spotlight turned onto West. Should he make a Lightner Double, hoping that partner could diagnose a diamond lead and that this lead would beat the contract? (When a pre-empter doubles, the double should be taken as Lightner even when the contract is not a slam.)

Sohtorik opted to pass and the ♠A was led. The contract could no longer be beaten because two diamond ruffs were required and the ♠A was the card of re-entry for the second ruff. That was +650 to N/S and 9 IMPs against the datum of +250.

The next board was a 3NT contract that would be very difficult to make:

Board 21. Dealer North. N/S Vul.

	♠ AJ965		
	♥ A53		
	♦ K5		
	♣ AJ7		
♠ 10742		♠ Q83	
♥ KQ8		♥ 10976	
♦ Q3		♦ J1042	
♣ KQ98		♣ 53	
	♠ K		
	♥ J42		
	♦ A9876		
	♣ 10642		
West	North	East	South
<i>Sohtorik</i>	<i>Vorobey</i>	<i>Baskan</i>	<i>Sliva</i>
—	1♣	Pass	1♦
Pass	1♠	Pass	2♦
Pass	2♠	Pass	3♣
Pass	3NT	All Pass	

Baskan found the best lead of the ♥10, ♥2, ♥8, ♥A. Vorobey continued with king, ace and another diamond. When they failed to split 3-3, the contract could not be made. He was one down for -100, a 2 IMP loss against a datum of -60.

At double-dummy, the contract can be made by playing on spades, guessing to drop the ♠Q on the third round (rather than pinning the ♠10 with the ♠J). You can then set up a ninth trick in clubs, losing just two hearts and a trick in each black suit – not a likely line in practical play. At Table 2, Dubinin managed to make +150 in 2NT for a 5-IMP gain.

Are you ready for the next board?

Board 22. Dealer East. E/W Vul.

♠ K75 ♥ AQ9842 ♦ 2 ♣ K83		♠ AJ94 ♥ 5 ♦ AJ7643 ♣ AQ	
♠ Q8 ♥ K ♦ KQ1085 ♣ 109754		♠ 10632 ♥ J10763 ♦ 9 ♣ J62	
West	North	East	South
<i>Sohtorik</i>	<i>Vorobey</i>	<i>Baskan</i>	<i>Sliva</i>
–	–	1♦	Pass
3♣	3♥	6♦	6♥
Double	All Pass		

Sohtorik showed his diamond support with the Criss-Cross convention (2♦ over 1♣ and 3♣ over 1♦). Vorobey entered with 3♥ and Baskan flew straight to 6♦. This is not a great slam, needing North to hold both the black kings. Since this was the case, Silva did well to sacrifice in 6♥. How much would that cost?

Baskan started well by underleading in diamonds (the only lead to take the contract five down with best play by both sides). West won with the ♦Q and switched to the ♣4, East scoring two tricks there. Baskan was pleased with his first underlead and decided to try another, reaching for the ♠4. West played the ♠Q and declarer won with the ♠K.

Declarer could have laid down the ♥A now to escape for four down. No, he suspected that East was void in trumps for his 6♦ bid and led the ♠5 instead. East won with the ♠J and continued with the ♠A. If West ruffs partner's ace with the ♥K, he can give his partner a club ruff. No, he discarded and declarer escaped for -800. This was worth 3 IMPs against a -900 datum.

For the fifth board we will all move to Table 2:

Board 23. Dealer South. All Vul.

♠ KJ63 ♥ A1083 ♦ J ♣ 8652		♠ 7 ♥ KJ62 ♦ AK543 ♣ Q109	
♠ 952 ♥ 954 ♦ Q7 ♣ AK743		♠ AQ1084 ♥ Q7 ♦ 109862 ♣ J	

West	North	East	South
<i>Andreev</i>	<i>Gromov</i>	<i>Samokhin</i>	<i>Dubiniv</i>
—	—	—	2♠
Pass	3♠	Double	Rdbl(!)
4♥	Double	All Pass	

♠ KJ63	♠ 952	♠ 7
♥ A1083	♥ 954	♥ KJ62
♦ J	♦ Q7	♦ AK543
♣ 8652	♣ AK743	♣ Q109
		
	♠ AQ1084	
	♥ Q7	
	♦ 109862	
	♣ J	

You don't understand South's redouble? Well, don't expect me to explain it. You will have to ask Alexander Dubinin if he pulled the wrong card out of the box.

As I see it, West should pass. He cannot be certain that 4♥ will make and he surely fancies his chances of beating 3♠. The penalty would have 1000. As it was, not only did the defenders score the first four tricks against 4♥, they also managed to double the contract. It was +200 and an 8-IMP gain against a datum of -120.

What a wonderful sequence of five boards. And in just 50 minutes time, as I write this, there will be another splendid lunch to enjoy!

You can replay these deals at: <http://tinyurl.com/zyhkw3s>

Round 8 Bridge of Spies

Bridge of Spies is a 2015 historical drama/legal thriller film directed and co-produced by Steven Spielberg starring Tom Hanks, Mark Rylance, Amy Ryan and Alan Alda. Based on the 1960 U2 incident during the Cold War, the film tells the story of lawyer James B. Donovan, who is entrusted with negotiating the release of Francis Gary Powers, a pilot whose U2 spy plane was shot down over the Soviet Union, in exchange for Rudolf Abel, a captive and convicted Soviet KGB spy held under the custody of the United States, who he represented at trial. The name of the film refers to the Glienicke Bridge, which connects Potsdam with Berlin, where the spy exchange took place.

Calling your plane U2 might give rise to confusion – it brought to mind this exchange from the film *Four Weddings and a Funeral*:

Henrietta: Charles! Charles, we must talk.

Charles: Right.

Henrietta: The thing is, Charlie, I've spoken to lots of people about you. Everybody agrees you're in real trouble, Charles.

Charles: Am I?

Henrietta: You see, you're turning into a kind of serial monogamist. One girlfriend after another, yet you never really let anyone near you. On the contrary... You're affectionate to them and sweet to them. Even to me, although you thought I was an idiot.

Charles: I did not.

Henrietta: You did. I thought U2 was a type of submarine.

Charles: In a way, you were right. Their music has a naval quality.

That reminded me that submarines have periscopes which enable them to see objects that are not in a direct line-of sight, which in turn brought to mind the player who was so well-known for attempting to look into his opponent's hands to the extent that he became known as Periscope....

After that somewhat lengthy preamble I expect you are anxious to see a deal.

In Round 8 the leaders faced a challenge from one of the Icelandic pairs.

Board 26. Dealer East. All Vul.

♠ Q 10 ♥ J 8 ♦ A Q 9 7 5 ♣ J 8 4 2		♠ 6 5 4 3 ♥ A K 10 ♦ J 4 2 ♣ A 9 7	♠ J 8 ♥ 9 5 4 3 2 ♦ K 8 6 3 ♣ 6 3
♠ A K 9 7 2 ♥ Q 7 6 ♦ 10 ♣ K Q 10 5			
West	North	East	South
<i>Ingimarsson</i>	<i>Vorobey</i>	<i>Eriksson</i>	<i>Sliva</i>
–	–	Pass	1♠
Pass	3NT	Pass	4♠
All Pass			

3NT Balanced spade raise

Another perfect slam hand for devotees of Bob Hamman. The spade suit will play for no loser just 40.6% of the time. In the cases where North can start with the more common 2NT to showing a forcing spade raise some partnerships will be playing that South can rebid 3♦ to show a shortage. In that scenario North has great controls but poor trumps, which suggest that a slam is unlikely to be bid.

Three pairs reached 6♠ – worth 13 IMPs.

Board 27. Dealer South. None Vul.

♠ 2 ♥ 10 6 5 2 ♦ K Q 4 2 ♣ 10 8 6 2		♠ Q 7 6 ♥ K 9 7 ♦ 9 6 ♣ A K 7 5 4	♠ K 9 8 5 3 ♥ A 8 ♦ A J 10 7 3 ♣ 3
♠ A J 10 4 ♥ Q J 4 3 ♦ 8 5 ♣ Q J 9			
West	North	East	South
<i>Ingimarsson</i>	<i>Vorobey</i>	<i>Eriksson</i>	<i>Sliva</i>
–	–	–	Pass
Pass	1♣*	1♠	Double*
Pass	1NT	2♦	2NT
3♦	3♥	All Pass	

It looks as if North took the view that South's 2NT was primarily a high card raise, promising nothing in diamonds, but you will appreciate that is mere speculation on my part.

East led his singleton club and declarer won with dummy's queen and played a heart to the nine. When that lost to the ace his problems were over and when East returned the three of spades declarer could win with the six, draw trumps, cash the clubs and repeat the spade finesse for +230 which proved to be worth 7 IMPs.

The key play was the finesse of the nine of hearts. If declarer plays the king East can win and play ace and another diamond and ruff the club return when West's ♥10 will be the setting trick. To defeat 3♥ East must find a spade lead, setting up ruffs for West.

4♥ can be defeated in several ways – one is for the defenders to play diamonds at every opportunity.

Board 31. Dealer South. N/S Vul.

	♠ A 10 9 6 ♥ A Q J 9 5 4 ♦ — ♣ 7 5 2		
♠ J 3 ♥ 10 8 7 ♦ 6 3 ♣ K Q J 9 6 4		♠ K Q 7 4 ♥ 6 2 ♦ A K Q 8 ♣ A 10 3	
	♠ 8 5 2 ♥ K 3 ♦ J 10 9 7 5 4 2 ♣ 8		
West	North	East	South
<i>Ingimarsson</i>	<i>Vorobey</i>	<i>Eriksson</i>	<i>Sliva</i>
—	—	—	Pass
2♠*	3♥	3♠	Pass
4♣	Pass	5♣	All Pass

It looks as if 2♠ showed a weak hand with a minor, which gave East a problem when North overcalled 3♥. As one of my contemporaries used to say when presented with this type of problem, 'Double and lead a trump'. (At the one table where the final contract was 3♥ doubled the opening lead was the ace of diamonds, but declarer contrived to go down.) That is quite a big position to take -perhaps at this vulnerability East can bid 3NT to say to partner – 'I have a good hand with a fit for both minors and game interest'. That's enough abstract theory for now.

North started with the ace of hearts and continued with the four, South winning and switching to the jack of diamonds. North ruffed and cashed the ace of spades, two down, +100 and 5 IMPs for the leaders, who scored an impressive win, 20-0 in IMPs.

You can replay these deals at: <http://tinyurl.com/jgsnd3h>

Round 9 The Cossacks

Because of their military tradition, Cossack forces have always played an important role in Russia's wars from the 18th century onwards. The Cossacks is a short novel by Leo Tolstoy, published in 1863 in the popular literary magazine The Russian Messenger. Tolstoy began work on the story in August 1853. In August 1857, after having reread the Iliad, he vowed to completely rewrite The Cossacks. It is believed to be somewhat autobiographical, partially based on Tolstoy's experiences during the last stages of the Caucasian War. Tolstoy had a morally corrupt experience in his youth, engaging in numerous promiscuous partners, heavy drinking and gambling problems and many argue he used his own past as inspiration for the book's main protagonist Olenin. In February 1862, after having lost badly at cards (was it bridge?) he finished the novel to help pay his debts (which might – or might not – explain why I am currently working on five different book projects).

In Round 9 the leaders faced another Icelandic pair, while their closest rivals took on Israel's Adi Asulin & Hila Levy – the reigning European Women's Pairs Champions.

Board 1. Dealer North. None Vul.

	♠ 976							
	♥ —							
	♦ KQ732							
	♣ AQJ95							
♠ 1085	<table style="border-collapse: collapse; margin: auto;"> <tr><td></td><td style="text-align: center;">N</td><td></td></tr> <tr><td style="text-align: center;">W</td><td style="text-align: center;">S</td><td style="text-align: center;">E</td></tr> </table>		N		W	S	E	♠ J43
	N							
W	S	E						
♥ KQJ65		♥ 109842						
♦ 965		♦ J8						
♣ K6		♣ 842						
	♠ AKQ2							
	♥ A73							
	♦ A104							
	♣ 1073							

West	North	East	South
<i>Asulin</i>	<i>Gromov</i>	<i>Levi</i>	<i>Dubin</i>
–	1♦*	Pass	1♠
Pass	1NT*	Pass	2♥*
Double	3♠	Pass	5NT*
Pass	6♣	All Pass	

- 1♦ 11-15, 4+♦ unbalanced
- 1NT 4+♣
- 5NT Pick a slam

East led the ten of hearts and declarer won with dummy's ace and advanced the ten of clubs, quickly claiming all the tricks, +940 and a couple of IMPs. The very small number of pairs who bid a grand slam found there luck was in to the tune of 11 IMPs.

As an aside, if the bidding starts 1♦-1♠-2♣-2♥* (Double) what do you think North should bid, 2♠ or 3♣? The latter would get my vote.

Board 4. Dealer West. All Vul.

	♠ Q ♥ Q1072 ♦ AQ742 ♣ 963		
♠ A10863 ♥ J9 ♦ K98 ♣ K108	<div style="border: 1px solid black; padding: 5px; width: 60px; margin: 0 auto;"> N W E S </div>	♠ K752 ♥ K86 ♦ J6 ♣ AJ72	
	♠ J94 ♥ A543 ♦ 1053 ♣ Q54		
West	North	East	South
<i>Asulin</i>	<i>Gromov</i>	<i>Levi</i>	<i>Dubin</i>
Pass	Pass	1♣	Pass
1♠	Pass	2♠	Pass
4♠	All Pass		

With a horrible hand to lead from North went with the six of clubs, covered by the jack, queen and king. When a spade to the king saw North contribute the queen declarer finessed on the next round, drew the outstanding trump, cashed three clubs pitching a heart and ran the jack of diamonds, eventually ruffing a diamond for her tenth trick, +620 and If North starts with the queen of spades declarer can still get home by taking the correct view in both black suits, but there are other complications and declarer will still need to take at least one more good view. Many went down in 4♠ (even after a club lead) and making it was worth 9 IMPs.

Board 6. Dealer East. E/W Vul.

	♠ AK1064 ♥ A ♦ Q104 ♣ A853		
♠ 7 ♥ Q54 ♦ AK32 ♣ KQ1094	<div style="border: 1px solid black; padding: 5px; width: 60px; margin: 0 auto;"> N W E S </div>	♠ J53 ♥ 98762 ♦ 95 ♣ 762	
	♠ Q982 ♥ KJ103 ♦ J876 ♣ J		
West	North	East	South
<i>Asulin</i>	<i>Gromov</i>	<i>Levi</i>	<i>Dubin</i>
-	-	Pass	Pass
1♦*	Double	Pass	2♦*
Pass	2♠	All Pass	

- 1♦ 3+♦, better minor, 11-21
- 2♦ Both majors

East led the nine of diamonds and West won with the king and slightly mysteriously returned the two, declarer winning with the queen, unblocking the ace of hearts, drawing trumps in three rounds ending in dummy, cashing the king of hearts to pitch a diamond and then playing the eight of diamonds and ruffing West's ace for eleven tricks, +200 but it cost 6 IMPs.

Board 8. Dealer West. None Vul.

	♠ KQ542 ♥ 62 ♦ J983 ♣ 74		
♠ 10763 ♥ Q3 ♦ A10642 ♣ J5		♠ 98 ♥ 109854 ♦ 75 ♣ Q863	
	♠ AJ ♥ AKJ7 ♦ KQ ♣ AK1092		

West	North	East	South
<i>Asulin</i>	<i>Gromov</i>	<i>Levi</i>	<i>Dubin</i>
Pass	2♠*	Pass	2NT*
Pass	3♦	Pass	3NT
All Pass			

2♠	5+♠ and a minor, 3-7
2NT	Asking

The match ended as it had begun, with a potential slam deal. The problem for South was that he might be facing a very weak hand. Even so, it was surprising he had no way of making at least one move.

West led the queen of hearts and declarer won with the ace and played the king of diamonds, continuing with the queen when it held. West ducked that too and when declarer next played the ace, king and ten of clubs he could claim 12 tricks, +490 and a couple of IMPs.

As the cards lie you make 6♠ and the two pairs who bid it earned 11 IMPs.

It was a good result for the European Champions, who won by 18 IMPs.

You can replay these deals at: <http://tinyurl.com/jznmqk>

Round 10 The Diamond Chariot

The Diamond Chariot, the Russian term for the "Diamond Vehicle" school of Tantric Buddhism) is a historical mystery novel by internationally acclaimed Russian detective story writer Boris Akunin, published originally in 2003. It is the tenth novel in Akunin's Erast Fandorin series of historical detective novels. As with all of the other Fandorin novels, The Diamond Chariot was hugely successful in Russia, selling out its first printing of 200,000 copies in a week.

I should dispel the rumour that David Bird and I are collaborating on a book in Russian. Having suffered a heavy defeat in the previous round, how would the leaders react in Round 10?

Board 10. Dealer East. All Vul.

	♠ 2		
	♥ KJ109842		
	♦ A972		
	♣ 3		
♠ 1093	<div style="border: 1px solid black; padding: 5px; display: inline-block; text-align: center;">N W E S</div>	♠ AKQ64	
♥ Q753		♥ 6	
♦ Q1063		♦ J5	
♣ 54		♣ QJ962	
	♠ J875		
	♥ A		
	♦ K84		
	♣ AK1087		
West	North	East	South
<i>Lankveld</i>	<i>Vorobey</i>	<i>Den Bos</i>	<i>Sliva</i>
-	-	1♠	Pass
1NT	3♥	Pass	4♥
All Pass			

East led the king of spades and continued with the queen, declarer ruffing, crossing to the ace of hearts, coming to hand with a diamond, cashing the king of hearts and exiting with the jack of hearts, +620.

Once East has played a second spade declarer has a chance of an extra trick. He ruffs, crosses to the ace of hearts, ruffs a spade, cashes two clubs pitching a diamond, ruffs a spade plays two rounds of diamonds, ruffs a club and exits with a diamond, taking all seven trumps and two tricks in each minor.

You might also squeeze East in the black suits for the overtrick, but that requires a defensive error.

Board 11. Dealer South. None Vul.

♠ 2 ♥ K9762 ♦ AK9 ♣ AQ62		♠ Q97654 ♥ Q104 ♦ 5 ♣ KJ8
♠ J3 ♥ J85 ♦ QJ6 ♣ 109743		♠ AK108 ♥ A3 ♦ 1087432 ♣ 5

West	North	East	South
<i>Lankveld</i>	<i>Vorobey</i>	<i>Den Bos</i>	<i>Sliva</i>
–	–	–	1♦
Pass	1♥	1♠	2♦
Pass	2♠*	Pass	2NT
Pass	3♦	Pass	3♥*
Pass	4♣*	Double	Pass
Pass	4♥*	Pass	4♠*
Pass	4NT*	Pass	5♣*
Pass	7♦	All Pass	

After a series of cue-bids North asked for key cards and when he discovered his partner held three he gambled that his partner would have the queen of diamonds.

West led the ten of clubs and declarer won with dummy's ace, cashed the ace of diamonds, played a heart to the ace and a diamond to the king. When East discarded declarer could do no better than twelve tricks by establishing dummy's hearts, -100 which cost 11 IMPs.

No doubt you have noticed that at double dummy you can make the grand slam by playing West for the ♦QJx – but it would need a very tall declarer!

Board 12. Dealer West. N/S Vul.

♠ A ♥ K63 ♦ 97432 ♣ QJ95		♠ Q1087642 ♥ J ♦ 6 ♣ 10642
		♠ K53 ♥ AQ974 ♦ AKJ ♣ A3
		♠ J9 ♥ 10852 ♦ Q1085 ♣ K87

West <i>Lankveld</i>	North <i>Vorobey</i>	East <i>Den Bos</i>	South <i>Sliva</i>
1NT	Pass	2♦*	Pass
2♥	2♠	Double	All Pass
	1NT 10-12		
	2♦ Transfer		

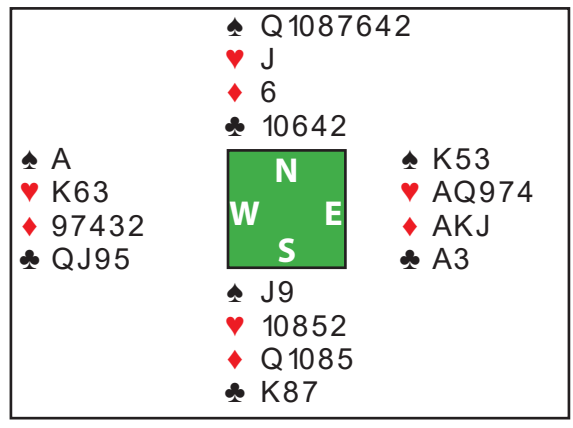

Before you read the narrative of the play, try and guess which card gave declarer a seventh trick.

East led the ace of diamonds and continued with the ace of clubs and a club, declarer winning with dummy's king and returning a club. West won with the queen as East pitched the jack of diamonds, cashed the ace of spades and switched to the six of hearts, East winning with the queen, cashing the king of spades and exiting with the four of hearts. When declarer played the five from dummy West followed with the three and declarer's club loser disappeared, only one down, -200 and 3 very lucky IMPs.

Board 13. Dealer North. All Vul.

	♠ QJ1043		
	♥ 7		
	♦ A108		
	♣ A983		
♠ 5		♠ K86	
♥ Q98		♥ AJ10632	
♦ QJ9732		♦ 4	
♣ J105		♣ KQ2	
	♠ A972		
	♥ K54		
	♦ K65		
	♣ 764		
West <i>Lankveld</i>	North <i>Vorobey</i>	East <i>Den Bos</i>	South <i>Sliva</i>
—	1♠	2♥	2NT*
4♦*	4♠	Double	All Pass
2NT	Spade raise		
4♦	Fit jump		

West's entry into the auction (I leave you to determine its merit) was enough for East to venture a double. He led his diamond and declarer took West's jack with the ace and ran the queen of spades. He repeated the finesse and then played a heart. East took the ace and exited with the king of spades, but declarer could claim -his losing diamond would go on the king of hearts and he could ruff a club in dummy, +790 and a 5 IMP pick up.

Despite the disaster on Board 11 the leaders showed great temperament and recorded a narrow win.

You can replay these deals at: <http://tinyurl.com/z35zrpn>

Round 11 Pictures at an Exhibition

Pictures at an Exhibition (*Pictures from an Exhibition – A Remembrance of Viktor Hartmann*) is a suite of ten pieces (plus a recurring, varied Promenade) composed for the piano by Russian composer Mussorgsky in 1874.

The suite is Mussorgsky's most famous piano composition and has become a showpiece for virtuoso pianists. It has become even better known through various orchestrations and arrangements produced by other musicians and composers, with Maurice Ravel's arrangement being the most recorded and performed.

Mussorgsky would have made a very good bridge player – his Christian name was Modest.

With the pack at their heels in Round 11 the leaders met the young Italian pair who are rapidly making a name for themselves, Massimiliano di Franco and Andrea Manno.

Board 21. Dealer North. N/S Vul.

	♠ 84 ♥ QJ10543 ♦ AQ7 ♣ Q5		
♠ A1062 ♥ — ♦ KJ10654 ♣ 1087	<div style="border: 1px solid black; background-color: #4CAF50; color: white; padding: 5px; display: inline-block;"> N W E S </div>	♠ 95 ♥ K862 ♦ 9 ♣ AK9642	
	♠ KQJ73 ♥ A97 ♦ 832 ♣ J3		
West	North	East	South
<i>Manno</i>	<i>Vorobey</i>	<i>Di Franco</i>	<i>Sliva</i>
–	1♥	2♣	Double*
2♦	2♥	Pass	3♥
4♣	Pass	Pass	4♥
Double	All Pass		

Having followed a sound invitational sequence which his partner declined, South allowed himself to be goaded into bidding his hand twice.

East led the nine of diamonds and when West played the ten declarer won with the queen, ran the queen of hearts, played a heart to the nine and the king of spades, West taking the ace and returning the king of diamonds. East ruffed declarer's ace and cashed two clubs for one down, +200 which cost 6 IMPs.

Board 23. Dealer South. All Vul.

♠ 1096 ♥ A875 ♦ 72 ♣ J862		♠ KJ54 ♥ J93 ♦ J4 ♣ KQ109	♠ A32 ♥ KQ102 ♦ K1096 ♣ 53
♠ Q87 ♥ 64 ♦ AQ853 ♣ A74			
West	North	East	South
<i>Manno</i>	<i>Vorobey</i>	<i>Di Franco</i>	<i>Sliva</i>
–	–	–	1♦*
Pass	1♥	Pass	2♥
Pass	Pass	Double	Pass
2♠	All Pass		

It is generally a sound principle to reopen when the opponents have advertised a fit but stopped at a low level.

Although West could not bid his best suit he was able to play in a suit where he could be virtually certain his partner held four cards.

North led the seven of diamonds and declarer took South's nine with the queen and played a heart for the nine and ten. South switched to the five of clubs and declarer won with dummy's nine and played a spade, South going up with the ace and playing a second club. Declarer won with the ace, drew trumps and claimed nine tricks, +140 and 3 IMPs.

Board 24. Dealer West. None Vul.

♠ K83 ♥ K1083 ♦ KQ85 ♣ 94		♠ QJ74 ♥ 9 ♦ A10643 ♣ K75	♠ 96 ♥ AQ72 ♦ 2 ♣ AJ8632
♠ A1052 ♥ J654 ♦ J97 ♣ Q10			
West	North	East	South
<i>Manno</i>	<i>Vorobey</i>	<i>Di Franco</i>	<i>Sliva</i>
Pass	Pass	1♦	2♣
Double	Pass	2♠	Pass
Pass	2NT	Pass	3♣
All Pass			

It was a mild surprise to see North pass at his first turn in the modern era. If the auction had started 1♦-1♥-2♥ East might have pre balanced (mildly risky) with a double and it is also possible that South might have taken a pot at 4♥ (which 3 pairs made!).

West led the seven of diamonds and East took dummy's king with the ace and returned the nine of hearts. Declarer won with dummy's ten, pitched a spade on the queen of diamonds and played two rounds of clubs,+110 and a 3 IMP pick up.

The Italians scored a narrow win and remained in the mix for the title.

You can replay these deals at: <http://tinyurl.com/j439bzn>

Round 12 Gorky Park

Gorky Park (more accurately Gorky Central Park of Culture and Leisure) is a central park in Moscow, named after Maxim Gorky. In 2011 it underwent a major reconstruction, which included the demolition of all the amusement rides but one. A 15,000 square meter ice rink, with separate zones for children, hockey, dancing, and general skating, was officially opened in December 2011. In a few months the park had been transformed and is recognised as one of the leading parks of the world.

The Park came to the attention of the world when it was used as the title for Martin Cruz Smith's book introducing the Investigator Arkady Renko which was turned into an award winning film in 1983.

If you are flying home tomorrow you might have time to visit the park- i can assure you it will be more interesting than the deals in yesterday's last round which the new leaders took on the pair in seventh place. Could they maintain their narrow lead going into the final day?

Board 27. Dealer South. None Vul.

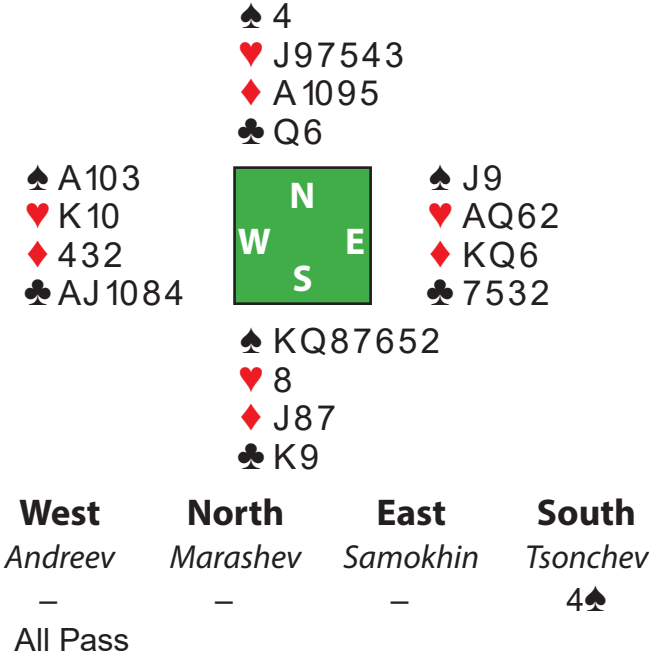

West led the ace of spades and switched to the jack of clubs, declarer winning with the king, drawing trumps and running the eight of diamonds. East won with the queen and returned a club, declarer finishing two down when the second diamond finesse also lost.

Should East have doubled 4♠?

In that case a pass by West and a more circumspect lead should produce +500.

If South starts with 3♠ then East is virtually certain to double when West will probably choose

between 3NT and a Pass. It's worth point out that with ♠A103 you will have the open of ducking spades twice, which may keep South out of the game.

Dubin in opened 2♦ and when Gromov responded 2♥ he jumped to 3♠ which silenced everyone. Two down as at the other table and a couple of IMPs to both N/S pairs. West might have doubled 2♦ and East could have done the same when 3♠ came round to him.

Board 31. Dealer South. N/S Vul.

♠ 7	♠ 103	♠ KQJ85
♥ A753	♥ KQJ1094	♥ 2
♦ KQ72	♦ 854	♦ J9
♣ QJ63	♣ 54	♣ K9872
	<div style="border: 1px solid black; padding: 5px; display: inline-block; text-align: center;"> N W E S </div>	
	♠ A9642	
	♥ 86	
	♦ A1063	
	♣ A10	

West	North	East	South
<i>Andreev</i>	<i>Marashev</i>	<i>Samokhin</i>	<i>Tsonchev</i>
—	—	—	1♠
Double	2♦*	Double	Pass
Pass	2♥	All Pass	

North's 2♦ was a transfer to hearts, but the meaning of East's double is unclear. How would you have found your nine card club fit? The simplest way is for East to bid 3♣.

2♥ was a walk in the park, declarer collecting five trumps and three aces for +110, which proved to be a rare plus score for N/S which gave them a windfall of 8 IMPs, enough to win the match by just 4 IMPs and retain the lead overnight.

You can replay these deals at: <http://tinyurl.com/gptvy4d>

Round 13 Dive From The Top Board *by David Bird*

The final day's play began with the Bulgarians, Vladimir Marashev and Ivan Tsonchev, in first place. They would not have been there without a very fine piece of dummy play on this deal from Round 11:

Board 24. Dealer West. None Vul.

	♠ K83 ♥ K1083 ♦ KQ85 ♣ 94		
♠ A1052 ♥ J654 ♦ J97 ♣ Q10		♠ QJ74 ♥ 9 ♦ A10643 ♣ K75	♠ 96 ♥ AQ72 ♦ 2 ♣ AJ8632
West	North	East	South
<i>Lankveld</i>	<i>Marashev</i>	<i>Den Bos</i>	<i>Tsonchev</i>
Pass	1♦	Pass	1♥
Pass	2♥	Pass	4♥
All Pass			

The ♦9 lead was covered by the king and ace, Tsonchev discarding a spade on the diamond return. The ♣9 went to the jack and queen. West then cashed the ♠A and returned to diamonds, forcing the South hand. As you see, setting up the clubs and hoping to draw trumps before enjoying the long clubs would be defeated by the 4-1 trump break.

Tsonchev played the ♥A, noting East's ♥9 with interest. Was it a singleton or part of ♥J-9? He continued with the ♣A and a third club. West showed out and declarer ruffed with the ♥8. If trumps had started 3-2, he could simply draw them with the king and queen, claiming the last three tricks with his ♣8-6-3. No, he decided that East's ♥9 had been a singleton. He called for the ♠K and ruffed a spade with the ♥7. He then led a club overruffing West's ♥5 with dummy's ♥10. It remained only to complete the crossruff, scoring his ♥Q and ♥K separately. Bravo! That was +420 and a 9-IMP gain over the datum of +0.

Play started on the final day with Dubinin and Gromov in 2nd place, breathing down the Bulgarians' backs (not literally, you understand). There were no problems for North/South on the first board:

Board 1. Dealer North. None Vul.

	♠ 642 ♥ 75 ♦ A9875 ♣ 943		
♠ 1093 ♥ 42 ♦ K6432 ♣ KQ5		♠ J8 ♥ KQJ8 ♦ QJ10 ♣ AJ108	
	♠ AKQ75 ♥ A10963 ♦ — ♣ 762		
West	North	East	South
<i>Ingimarsson</i>	<i>Marashev</i>	<i>Eriksson</i>	<i>Tsonchev</i>
—	Pass	1NT	2♣ *
3NT	All Pass		

Kibitzers on *Bridge Base Online* did not need to reach for the GIB double-dummy button to assess the prospects of this contract. Tsonchev and Marashev swiftly reaped their seven tricks for +150, worth 2 IMPS against a datum of +100.

West	North	East	South
<i>Gusev</i>	<i>Gromov</i>	<i>Nikitina</i>	<i>Dubinina</i>
—	Pass	1NT	2♥ *
3♣ *	Pass	3♦	Double
Pass	3♠	4♦	4♠
All Pass			

At the other table, Dubinin and Gromov had the possibility of doubling 4♦. They went one down in 4♠ for -50 and 4 IMPs away.

Board 2. Dealer East. N/S Vul.

	♠ — ♥ AK10986 ♦ AK973 ♣ QJ		
♠ A82 ♥ Q75 ♦ Q862 ♣ A108		♠ QJ76 ♥ J432 ♦ — ♣ 97432	
	♠ K109543 ♥ — ♦ J1054 ♣ K65		

West	North	East	South
<i>Ingimarsson</i>	<i>Marashev</i>	<i>Eriksson</i>	<i>Tsonchev</i>
—	—	Pass	2♦
Pass	4♥	All Pass	

♠ —	♥ AK10986	♦ AK973	♣ QJ
♠ A82	♥ Q75	♦ Q862	♣ A108
♠ QJ76	♥ J432	♦ —	♣ 97432
♠ K109543	♥ —	♦ J1054	♣ K65

Tsonchev opened with a multi and after some thought Marashev abandoned science and leapt to 4♥. East led the ♣2 and West played the ♣10, not wishing to set up the ♣K as an entry to dummy. Declarer won and played ace, king and another trump to West's queen. When West returned the ♦8, declarer rose with the ace, ruffed by East. West took his ace on the club return and declarer was left with a diamond loser after ruffing West's ♠A. That was -100 and 4 IMPs away against the datum of +60.

There was bad news for the Bulgarians from Table 2. Gromov had made 4♥ for +620 and +11 IMPs. How did that happen? Let's see. Nikitina (East) led a club and Gusev won immediately with the ♣A, declarer playing the ♣Q. Gromov rose with the ♦A on the ♦2 return, East ruffing. To beat the contract after this start, East must find the difficult continuation of a second club. Since this might allow a spade discard if the ♣Q was singleton, she preferred to switch to the ♠J. Curtains! Gromov ruffed and played ace, king and another trump. He could then claim the contract, using the ♣K as an entry for the diamond finesse.

Another 'big one' arrived shortly afterwards:

Board 4. Dealer West. All Vul.

		♠ K654		
		♥ J6		
		♦ J10984		
		♣ Q3		
♠ AQ			♠ J832	
♥ KQ843			♥ 1075	
♦ 72			♦ AKQ5	
♣ A942			♣ KJ	
		♠ 1097		
		♥ A92		
		♦ 63		
		♣ 108765		

West	North	East	South
<i>Ingimarsson</i>	<i>Marashev</i>	<i>Eriksson</i>	<i>Tsonchev</i>
1♥	Pass	1♠	Pass
2♣*	Pass	2♦*	Pass
2NT	Pass	3♥	Pass
3♠	Pass	3NT	Pass
4♣	Pass	4♦	Pass
4NT	Pass	5♣	Pass
6♥	All Pass		

A hailstorm of cue-bids left the Icelanders in a somewhat poor slam. Any lead but a diamond would help declarer considerably. The Bridge Gods had been kind to Marashev, giving him a diamond sequence.

Ingimarsson won with dummy's $\spadesuit A$ and played a trump to the king and 6. Good luck so far. After some thought he diagnosed that he would need a club finesse. A club to the jack won. More good luck!

The hot-spot of the deal had been reached when declarer called for another trump from dummy. To beat the slam South must rise with the $\heartsuit A$ and return... a diamond! With the spade finesse offside, declarer cannot then do everything that he would like to do.

In practice, Tsonchev played low on the second trump. Ingimarrson won, crossed to the $\clubsuit K$ and played the $\diamond K-Q$, ditching the $\spadesuit Q$. He could then cross to the $\spadesuit A$ and ruff his club loser with dummy's last trump. -1430 to the Bulgarians and a horrible 13 IMPs away against the datum of -580.

At Table 2, Gromov and Dubinin lost 650 in $4\heartsuit$ for 2 IMPs away. The remaining four boards of the first set were uneventful. The Russians won 35-25 and the Bulgarians lost 9-51, tumbling from top spot to 3rd place.

You can replay the deals at: <http://tinyurl.com/h92apae>

Round 14 Triumph and Disaster

If I had to choose a poem to represent the trials and tribulations that bridge players undergo during a tournament it would be a condensation of Rudyard Kipling's IF:

*If you can keep your head when all about you
Are losing theirs and blaming it on you,
If you can trust yourself when all men doubt you,
But make allowance for their doubting too;
If you can dream – and not make dreams your master;
If you can think – and not make thoughts your aim;
If you can meet with Triumph and Disaster
And treat those two impostors just the same;
If you can fill the unforgiving minute
With sixty seconds' worth of distance run,
Yours is the Earth and everything that's in it,
And – which is more – you'll be a Man, my son!*

In the previous round the overnight leaders had suffered a heavy defeat and been knocked off their perch. How would they react in Round 14? Both they and the new leaders faced a challenge from the Orangemen.

Board 9. Dealer North. E/W Vul.

	\spadesuit KQ7	
	\heartsuit AK10876	
	\diamond 92	
	\clubsuit 98	
\spadesuit J9864	<div style="display: flex; justify-content: space-between; align-items: center;"> N </div> <div style="display: flex; justify-content: space-between; align-items: center;"> W E </div> <div style="display: flex; justify-content: space-between; align-items: center;"> S </div>	\spadesuit A1052
\heartsuit 5432		\heartsuit J9
\diamond Q		\diamond J874
\clubsuit A75		\clubsuit Q63
	\spadesuit 3	
	\heartsuit Q	
	\diamond AK10653	
	\clubsuit KJ1042	

West	North	East	South
<i>Lankveld</i>	<i>Gromov</i>	<i>den Bos</i>	<i>Dubin</i>
–	1♥	Pass	2♦
Pass	2♠*	Pass	3♣
Pass	3♥	Pass	4♣
Pass	4♠	Double	5♣
All Pass			

2♠ is not defined on the convention card.

West led the four of spades and East took dummy's king with the ace and switched to the jack of hearts. Declarer won with the queen and tried to cash the top diamonds. West ruffed the second of these and played the ace of clubs and a club which left declarer trapped in hand and forced to lead into East's diamond tenace for three down, -150 and a loss of 7 IMPs.

4♥ can be made, however, some care is needed. On a diamond lead declarer wins in dummy and must overtake the queen of hearts. If North ends up in 3NT the heart position delivers nine easy tricks.

Board 10. Dealer East. All Vul.

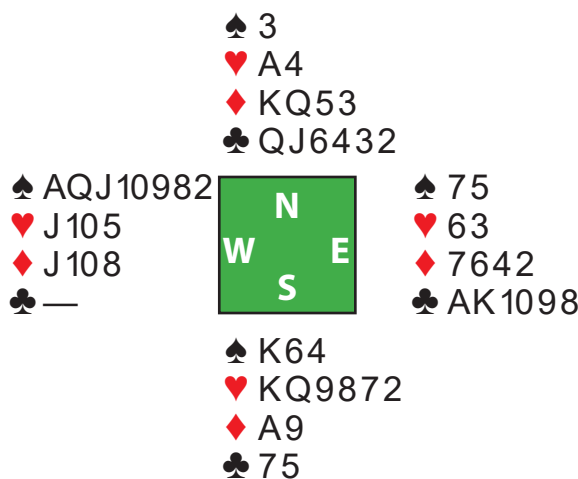

West	North	East	South
<i>Lankveld</i>	<i>Gromov</i>	<i>den Bos</i>	<i>Bubin</i>
–	–	Pass	1♥
3♠	Double*	4♣	Pass
4♠	Double	All Pass	

You can understand why East bid 4♣ – but I think you need better trump support than ♠75.

North led the king of diamonds and continued with the three, South taking the ace and switching to the king of hearts, followed by the nine. North won with the ace, cashed the queen of diamonds and exited with a spade, declarer winning with the queen and ruffing his losing heart. There was still a trump to lose, three down, -800 and 9 IMPs for N/S.

You will observe that on this layout 3NT is unbeatable, but 4♥ should go down on a trump lead. It might also fail on a diamond lead, but there is a way to make it.

Declarer must win in dummy and play a spade. West wins and plays a second diamond 9as good as anything) and declarer wins in hand, ruffs a spade, cashes the ace of hearts, ruffs a diamond, draws trumps and plays a club to the queen, endplaying East.

The new leaders managed a narrow win; meanwhile at table two Sliva and Voobey made it 2-0 in the Russia-Netherlands encounters, a good win moving them ever closer. The Bulgarians lost badly for a second time while Baldursson & Haraldsson won the all Icelandic clash to move into third place.

You can replay the deals at: <http://tinyurl.com/hgg83wr>

Round 15 The Double

My title refers to the novella written by the celebrated Russian author, Fyodor Dostoyevsky, first published in 1846.

It concerns a government clerk who goes mad. It deals with the internal psychological struggle of its main character, Yakov Petrovich Golyadkin, who repeatedly encounters someone who is his exact double in appearance but confident, aggressive, and extroverted, characteristics that are the polar opposites to those of the toadying "pushover" protagonist. The motif of the novella is a doppelgänger.

It would be asking a lot for Round 15 to include a raft of doubles—but that is part of the fun of bridge—you can never be sure what will happen.

The only place to be was at table 1 for the match between the top two. When they met in Round 3 there were only 2 IMPs in it.

Board 18. Dealer East. N/S Vul.

	♠ A9		
	♥ AQ953		
	♦ AK		
	♣ A1095		
♠ Q65		♠ K43	
♥ J876		♥ 104	
♦ Q85		♦ J962	
♣ KQ4		♣ 8762	
	♠ J10872		
	♥ K2		
	♦ 10743		
	♣ J3		
West	North	East	South
<i>Sliva</i>	<i>Gromov</i>	<i>Vorobey</i>	<i>Dubin</i>
–	–	Pass	Pass
Pass	1♣*	1♠*	Pass*
1NT*	Double	2♣*	2♠
Pass	3♥	Pass	4♥
All Pass			
1♣	Precision		

There is little point in making a random overcall when you are defending against a strong club system. The only effective defences are those which enable you to show distributional hands.

I do not know the precise meaning of East's 1♠—perhaps it is just as well. In a way it's a pity South did not pass over 2♣ as I would have liked to see where E/W would have come to rest—and they would have been doubled. 2♣ goes for 800—and who knows E/W might have played somewhere else.

East led the seven of clubs for the queen and ace and when declarer returned a club to the jack West won and switched to the five of diamonds. Declarer won with the ace, played three rounds of trumps and claimed ten tricks, +620.

Board 20. Dealer West. All Vul.

♠ K6 ♥ AQ43 ♦ K4 ♣ J9864		♠ Q103 ♥ J10972 ♦ Q9 ♣ Q103	
♠ 75 ♥ 865 ♦ A10532 ♣ AK7		♠ AJ9842 ♥ K ♦ J876 ♣ 52	

West	North	East	South
<i>Sliva</i>	<i>Gromov</i>	<i>Vorobey</i>	<i>Dubin</i>
1♦	Pass	1♥	1♠
Double*	Redouble	2♥	2♠
Pass			

Double Support Double

North took a long time over 2♠ – how useful would the queen of hearts be? Still, with partner likely to have six spades and a singleton heart he eventually decided to make a try by raising to 3♠. South did have six spades, but perhaps imagining his ♥K would be worthless he let matters rest.

He had forgotten Meckstroth's Law – 'when partner raises your six card major, bid game'.

West started with three rounds of clubs and declarer ruffed, crossed to the king of spades, played a spade to the ace and gave up a spade, +140 and no swing, but with few pairs bidding game it was a missed opportunity that would have delivered 10 IMPs.

Board 23. Dealer South. All Vul.

♠ J763 ♥ 543 ♦ A85 ♣ A82		♠ Q5 ♥ Q108 ♦ KQ762 ♣ K103	
♠ AK9842 ♥ — ♦ J1093 ♣ Q96		♠ 10 ♥ AKJ9762 ♦ 4 ♣ J754	

West	North	East	South
<i>Sliva</i>	<i>Gromov</i>	<i>Vorobey</i>	<i>Dubin</i>
—	—	—	4♥
4♠	5♥	Double	All Pass

With two aces and a likely trump trick North might have been tempted to double 4♠, but he

eventually took the winning decision to bid 5♥. West led the ace of spades and continued with the two, declarer ruffing, cashing the ace of hearts, crossing to the ace of clubs and playing a second club. With the suit dividing 3-3 declarer has ten tricks, one down, -200 which gave N/S 4 IMPs.

Board 24. Dealer West. None Vul.

♠ A9	♠ J10643	♠ Q7
♥ A974	♥ 65	♥ J8
♦ 642	♦ 10973	♦ QJ5
♣ KQ108	♣ J2	♣ A97653
	<div style="border: 1px solid black; width: 40px; height: 40px; margin: 0 auto; display: flex; flex-direction: column; align-items: center; justify-content: center;"> <div style="width: 100%; height: 100%; background-color: #008000; color: white; display: flex; flex-direction: column; align-items: center; justify-content: center;"> N W S E </div> </div>	
	♠ K852	
	♥ KQ1032	
	♦ AK8	
	♣ 4	

West	North	East	South
<i>Sliva</i>	<i>Gromov</i>	<i>Vorobey</i>	<i>Dubin</i>
1♣	Pass	2NT	Pass
3NT	All Pass		

South led the king of hearts and when it held he continued with the queen, declarer winning with dummy's ace and returning the seven, establishing a ninth trick, +400 and 7 IMPs – the only swing for E/W in the match, but a vital one, keeping them in the hunt.

Played by East, 3NT is unbeatable, but if West is declarer a spade lead (the jack is sure to beat the contract, but even if North starts with a low spade I doubt declarer would find the play of withholding dummy's queen).

You can replay the deals at: <http://tinyurl.com/gt9468f>

Round 16 The Last Command

On the day on which the Oscars will be presented it seems appropriate to remind you of one of the first winners back in 1929.

The Last Command is a 1928 silent film directed by Josef von Sternberg, and written by John F. Goodrich and Herman J. Mankiewicz from a story by Lajos Bíró. Star Emil Jannings won the very first Academy Award for Best Actor in a Leading Role for his performances in this film and The Way of All Flesh, the only year that multiple roles were considered. In 2006, the film was deemed "culturally, historically, or aesthetically significant" by the United States Library of Congress and selected for the National Film Registry.

The film is set in Russia at the time of the revolution and revolves around Grand Duke Sergius Alexander, the Czar's cousin and commander of his armies. A heart-rending love story it is available on both Blu-ray and DVD.

Going in to the last round the leaders were 15 VP ahead.

Board 27. Dealer South. None Vul.

♠ K9642 ♥ 75 ♦ J54 ♣ K108		♠ J108 ♥ 642 ♦ AQ10 ♣ A742
♠ AQ73 ♥ 108 ♦ K972 ♣ QJ5		♠ 5 ♥ AKQJ93 ♦ 863 ♣ 963

West	North	East	South
<i>Sliva</i>	<i>Gromov</i>	<i>Vorobey</i>	<i>Dubinina</i>
-	-	-	1♥
Double	1♠	Double	2♥
Pass	Pass	3♣	All Pass

South led the ace of hearts and switched to the five of spades. When declarer played dummy's three North won with the king and returned the nine of spades. South ruffed, cashed the jack of hearts and followed it with the king, ruffed by dummy's queen and overruffed by North, who played a third spade for South to ruff. There still a trump trick to come, two down, -100 and 2 IMPs for the leaders.

When the last deal flashed up onto the screen a quick glance at the scores revealed that Iceland's Jon Baldursson & Sigurbjorn Haraldsson had finished their match at table two and led by a single IMP! In order to secure victory Gromov & Dubinin needed to score and IMP as a tie would be split in their favour.

Board 32. Dealer West. E/W Vul.

♠ KQ10954 ♥ K104 ♦ K8 ♣ K8		♠ J7 ♥ J865 ♦ Q943 ♣ 754
♠ A832 ♥ A9 ♦ A1075 ♣ AJ9		♠ 6 ♥ Q732 ♦ J62 ♣ Q10632

West	North	East	South
<i>Sliva</i>	<i>Gromov</i>	<i>Vorobey</i>	<i>Dubinina</i>
1NT	Double	Pass	2♣
Pass	2♠	All Pass	

East led the three of diamonds and West won with the ace and returned the five, declarer winning with the king and playing the king of clubs, West taking the ace and returning the seven of diamonds. Declarer ruffed, played the queen of spades and continued with the king when it held. The appearance of East's jack meant he was sure of eight tricks, +110.

That was worth exactly 1 IMP!

You can replay the deals at: <http://tinyurl.com/zy4fv99>

Swiss Pairs Final Ranking

1	DUBININ - GROMOV	595.0	30	DANILEVSKIY - TYUKHLOV	473.0
2	BALDURSSON - HARALDSSON	594.0	31	LORENCIS - RUBINS	473.0
3	SLIVA - VOROBAY	586.0	32	KOZLOV - PETRUNIN	470.0
4	KAZANTSEV - MATUSHKO	565.0	33	GALAKTIONOVA - STOLBOVSKIY	467.0
5	VAN DEN BOS - VAN LANKVELD	554.0	34	RAKHMANI - YAKOVLEVA	465.0
6	GUSEV - NIKITINA	552.0	35	BERKTAS - KANDEMIR	463.0
7	ANDREEV - SAMOKHIN	544.0	36	PAVLUSHKO - RUDAKOVA	459.0
8	ERIKSSON - INGIMARSSON	544.0	37	KOWALSKI - ROMANSKI	458.0
9	MARASHEV - TSONCHEV	539.0	38	ROZENBLYUM - VOROBAYCHIKOVA	456.0
10	HELNESS - HELNESS	539.0	39	VORONOV - ZAYTSEV	455.0
11	DI FRANCO - MANNO	534.0	40	AZARYEVA - SERBIN	454.0
12	FRIEDLANDER - LIRAN	534.0	41	BAVSHIN - KHYUPPENEN	452.0
13	DANAIOV - STAMATOV	532.0	42	CHUMAK - ROVYSHYN	450.0
14	FRANCHI - LANZAROTTI	528.0	43	BEKESEVICH - RYBIN	445.0
15	GULEVICH - KHONICHEVA	522.0	44	KYCHANOV - ROGOV	443.0
16	KHOLOMEYEV - SEMENOV	522.0	45	ARTAMONOV - NAYMUSHIN	442.0
17	DRIJVER - NAB	504.0	46	KONDRASHENKO - LYANDIN	435.0
18	CAPPELLETTI - SIGURJONSSON	504.0	47	KHOKHLOV - RUDAKOV	433.0
19	SENIOR - TRENDAFILOV	502.0	48	BAKAL - TATARKIN	430.0
20	GOMEROV - PROKHOROV	499.0	49	KOSHELEV - MITYAGINA	426.0
21	GROMOVA - PONOMAREVA	492.0	50	CHUBAROVA - RAPOPORT	420.0
22	BANIRI - KHUTORSKY	491.0	51	REKUNOV - ZENKEVICH	408.0
23	RYBNIKOV - TATARKIN	491.0	52	CAILLIAU - ZVEZDIN	405.0
24	KHAZANOV - LEBEDEVA	490.0	53	GARKAVYI - VOLKOV	400.0
25	BASKAN - SOHTORIK	488.0	54	GUDKOV - KURSAKOVA	397.0
26	PEREKHREST - SHUDNEV	487.0	55	CLAIR - DE MICHELIS	394.0
27	GERASIMOV - ORLOV	486.0	56	DRUTS - GALAKTIONOV	382.0
28	JANSONS - ROMANOVSKA	485.0	57	BREWIAK - HAYMAN	374.0
29	ASULIN - LEVI	483.0	58	BIZER - RISKIN	299.0